

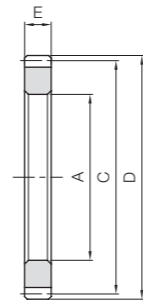

# Steel Ring Gears (Spur Gears)



Specifications	
Precision grade	JIS grade N9 (JIS B1702-1: 1998)
Gear teeth	Standard full depth
Pressure angle	20°
Material	S45C
Heat treatment	—
Tooth hardness	(less than 194HB)



S5

Catalog Number	Module	No. of teeth	Shape	Bore		Pitch dia.		Outside dia.		Face width		Allowable torque (N·m)		Allowable torque (kgf·m)	
				A <sub>H8</sub>	C	C	D	D	E	Bending strength	Surface durability	Bending strength	Surface durability		
<b>SSR2-120</b> <b>SSR2-200</b>	<b>m2</b>	120 200	S5	194 354	240 400	244 404	20	366 630	44.0 84.2	37.4 64.3	4.49 8.59				
<b>SSR2.5-120</b> <b>SSR2.5-200</b>	<b>m2.5</b>	120 200	S5	245 445	300 500	305 505	25	715 1230	88.5 169	72.9 126	9.02 17.2				
<b>SSR3-120</b> <b>SSR3-160</b>	<b>m3</b>	120 160	S5	296 416	360 480	366 486	30	1240 1680	157 226	126 171	16.0 23.0				

Backlash (mm)	Weight (kg)	Catalog Number
0.12~0.26	2.46 4.28	<b>SSR2-120</b> <b>SSR2-200</b>
0.14~0.28	4.62 8.01	<b>SSR2.5-120</b> <b>SSR2.5-200</b>
0.14~0.32	7.77 10.6	<b>SSR3-120</b> <b>SSR3-160</b>

## Steel Ring Gears (Spur Gears)



# Helical Gears

KHG Ground Helical Gears	SH Helical Gears
Material: SCM440 m1-3 Page 194	Material: S45C m2, 3 Page 202

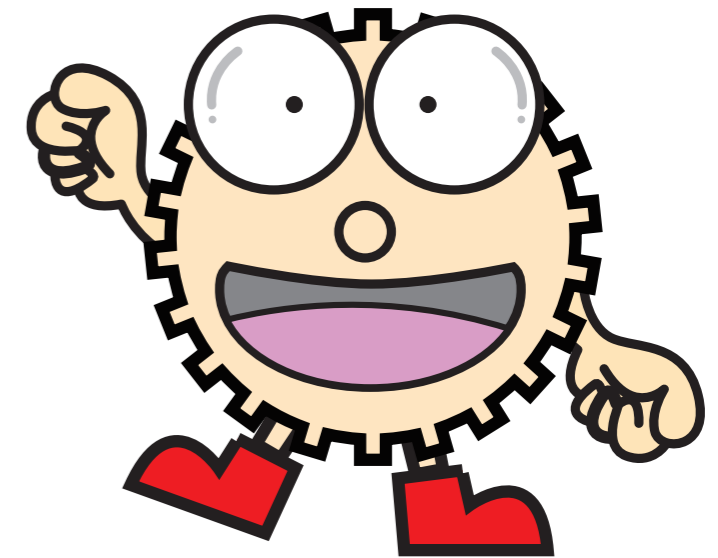

## Catalog Number of KHK Stock Gears

The Catalog Number for KHK stock gears is based on the simple formula listed below. Please order KHK gears by specifying the Catalog Numbers.

(Example) Helical Gears

**K H G 1 - 20 R**

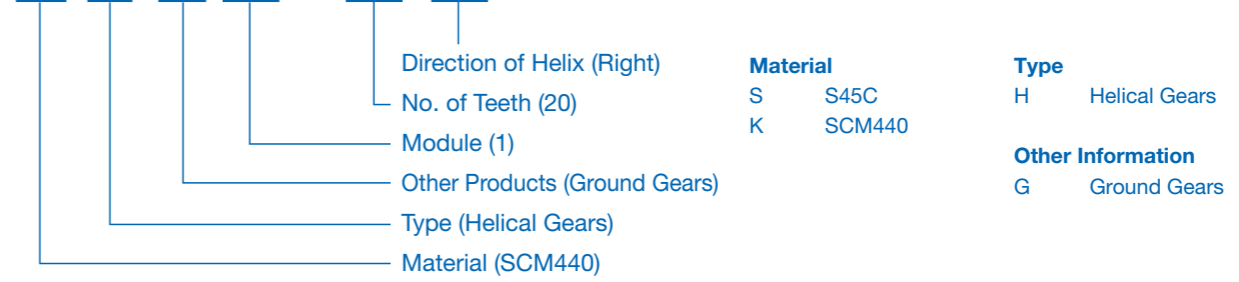

- Spur Gears
- Helical Gears
- Internal Gears
- Racks
- CP Racks & Pinions
- Miter Gears
- Bevel Gears
- Screw Gears
- Worm Gears
- Gearboxes
- Other Products

- Spur Gears
- Helical Gears
- Internal Gears
- Racks
- CP Racks & Pinions
- Miter Gears
- Bevel Gears
- Screw Gears
- Worm Gears
- Gearboxes
- Other Products

### Features



KHK stock helical gears are quiet, high-strength and easy to use. They are suitable wherever you require high-speed rotation including in machine tools, speed reducers, etc. The following table lists the main features.

Catalog Number	KHG	SH
Module	1~3	2~3
Reference section of gear	Rotating plane	Normal plane
Material	SCM440	S45C
Heat Treatment	Thermal refined, gear teeth induction hardened	—
Tooth Surface Finish	Ground	Cut
Precision JIS B 1702-1:1998	N6	N8
Secondary Operations	Possible except for tooth	Possible
Features	It has excellent accuracy, strength, wear resistance and quietness, and allows secondary operations. Usable in the same center distance of the spur gear.	It has higher strength and quietness than the SS spur gears.

### Selection Hints



It is important to thoroughly understand the contents of the product tables as well as "CAUTION" notes before making the selection. You must specify the right or left hand by including the letter R or L in the catalog number when ordering.

#### 1. Caution in Selecting the Mating Gears

The KHK stock helical gears KHG series (transverse module) and SH series (normal module) are not interchangeable. Please keep this in mind when making your selection. Also, right hand and left hand helical mating gears operate as a set. See the photos below for reference and for help in making a proper selection.

#### Direction of Helix

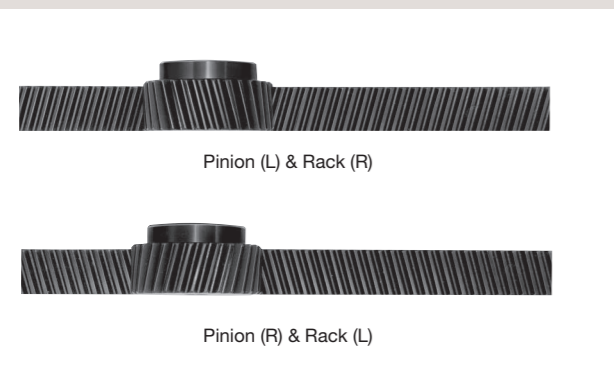

#### Mating Helical Gear Selection Chart (○ Allowable × Not allowable)

Catalog Number and Direction of Helix	KHG		SH		KRHG KRHGF		SRH		
	RH	LH	RH	LH	RH	LH	RH	LH	
KHG	RH	×	○	×	×	×	○	×	×
	LH	○	×	×	×	○	×	×	×
SH	RH	×	×	×	○	×	×	×	○
	LH	×	×	○	×	×	×	○	×

#### 2. Caution in Selecting Gears Based on Gear Strength

The gear strength values shown in the product pages were computed by assuming the application environment in the table below. Therefore, they should be used as reference only. We recommend that each user computes their own values by applying the actual usage conditions.

#### Calculation of Bending Strength of Gears

Item	Catalog Number	KHG	SH
Formula NOTE 1		Formula of spur and helical gears on bending strength (JGMA401-01)	
No. of teeth of mating gears		Same no. of teeth	
Rotational Speed		600rpm	100rpm
Design Life (Durability)		Over 10 <sup>7</sup> cycles	
Impact from motor		Uniform load	
Impact from load		Uniform load	
Direction of load		Bidirectional load (calculated with allowable bending stress of 2/3)	
Allowable bending stress at root $\sigma_{Fim}$ (kgf/mm <sup>2</sup> ) NOTE 2		30	19
Safety factor $S_F$		1.2	

#### Calculation of Surface Durability (Except where it is common with bending strength)

Item	Catalog Number	KHG	SH
Formula NOTE 1		Formula of spur and helical gears on surface durability (JGMA402-01)	
Kinematic viscosity of lubricant		100cSt(50°C)	
Gear support		Symmetric support by bearings	
Allowable Hertz stress $\sigma_{Hlim}$ (kgf/mm <sup>2</sup> )		116	49
Safety factor $S_H$		1.15	

[NOTE 1] The gear strength formula is based on JGMA (Japanese Gear Manufacturers Association) specifications. The units for the rotational speed (rpm) and the stress (kgf/mm<sup>2</sup>) are adjusted to the units needed in the formula.

### Product Precautions



#### Common Notes

#### [Caution on Product Characteristics]

- (1) The allowable torque shown in the table are calculated values according to the assumed usage conditions. Please see Page 190 for more details.
- (2) The backlash values shown in the table are the theoretical values for the backlash in the normal direction of gears of the same series in mesh.
- (3) A set of helical gears must be identical in module and number of teeth, but opposite in spiral hands.
- (4) These helical gears produce axial thrust forces. Please see Page 193 for more details.
- (5) For the helical gear series combinations, see the Mating Gear Selection Chart on Page 190.
- (6) Keyways are made according to JIS B1301 standards, Js9 tolerance. Also note that keyway tooth position alignment is not performed.
- (7) For products having a tapped hole, a set screw is included.

#### [Caution on Secondary Operations]

- (1) Please read "Cautions on Performing Secondary Operations" on Page 192 when performing modifications and/or secondary operations for safety concerns.
- (2) Due to the gear teeth being induction hardened, no secondary operations can be performed on tooth areas including the bottom land (approx. 2 to 3 mm).

#### [J Series]

- (1) Cancellation is not possible for made-to-order products. For lead time details, see Page 38.
- (2) Certain products which would otherwise have a very long tapped hole are counterbored. For details, please see the KHK website.
- (3) Black oxide is not re-applied to parts undergoing secondary operations.
- (4) For bores over  $\phi 50$ , the bore tolerance is H8.

#### KHG Ground Helical Gears

#### [Caution on Secondary Operations]

- (1) Because of the influence of hardening residual stress, avoid removing the entire boss, as it may cause the gears to deform.

### Application Hints



In order to use KHK stock gears safely, carefully read the Application Hints before proceeding. If there are questions or you require clarifications, please contact our technical department or your nearest distributor.

E-mail: info@khkgears.net

#### 1. Caution on Performing Secondary Operations

- ① If re boring, it is important to pay special attention to locating the center in order to avoid runout.
- ② The reference datum for gear machining is the bore. Therefore, use the bore for locating the center. If it is too difficult to do for small bores, the alternative is to use one spot on the bore and the runout of the side surface.
- ③ If reworking using scroll chucks, we recommend the use of new or rebored jaws for improved precision. Please exercise caution not to crush the teeth.

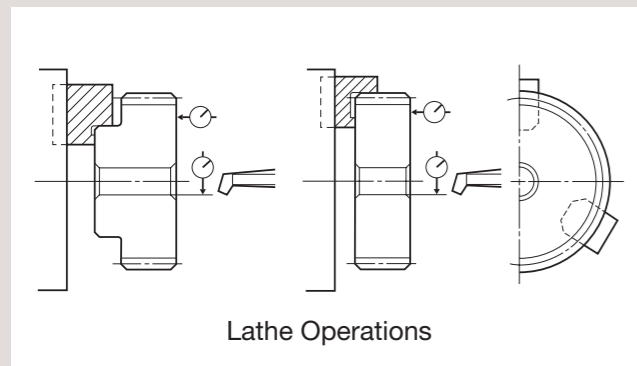

- ④ The maximum bore size is dictated by the requirement that the strength of the hub is to be higher than that of the gear teeth. The maximum bore size should be 60% to 70% of the hub diameter (or tooth root diameter), and 50% to 60% for keyway applied modifications.
- ⑤ In order to avoid stress concentration, round the keyway corners.

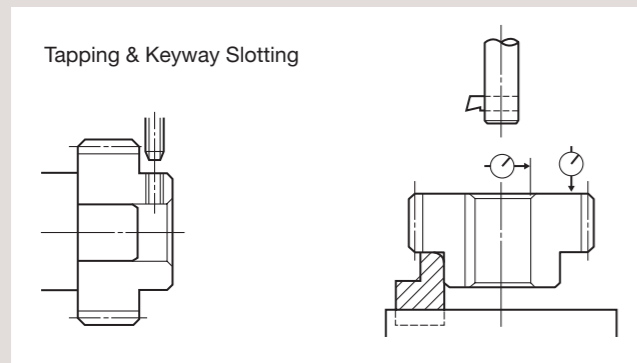

- ⑥ To avoid problems of reduced gear precision and other manufacturing difficulties, do not attempt to machine the gears to reduce face widths.
- ⑦ When induction-hardening S45C products, thermal stress cracks may appear. Also, note that the precision grade of the product declines by 1 or 2 grades, as deformation on material may occur. If you require tolerance for bore or other parts, machining is necessary after heat treatment.

#### 2. Points of Caution during Assembly

- ① The recommended center distance tolerance of KHK stock helical gears is H7 for ground gears and H8 for cut gears. The amount of backlash is given in the product table for each gear. For the center distance of SH, refer to the dimensional table page.

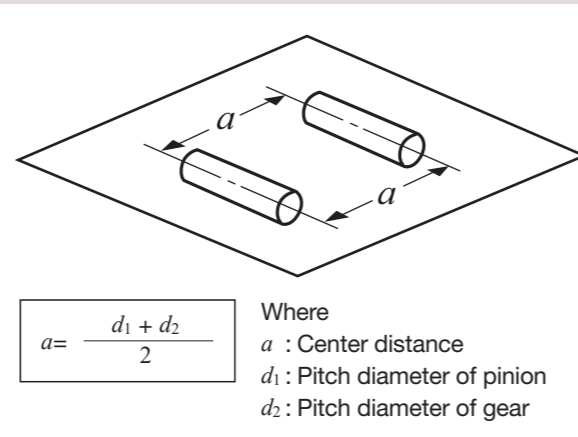

- ② The table below indicates the tolerance on the total length of KHK stock spur gears. Please refer to this data when designing gearboxes or other components.

##### ■ Total Length Tolerance for Spur and Helical Gears

Total Length (mm)	Tolerance
30 or less	0 -0.10
31 to 100	0 -0.15
Over 100	0 -0.20

[Note] The following products are excluded from this table: Spur pinion shafts, Injection molded spur gears, F-loc hub spur gears, and MC nylon products.

- ③ Verify that the two shafts are parallel. Incorrect assembly will lead to uneven teeth contact which will cause noise and wear. (After assembly, check the tooth contact by painting a thin layer of red lead primer or the like on the gear teeth, meshing them together and rotating them.)

■ Test example: Abrasion occurred on SSG3-30 due to poor edge contact (only 30% with proper contact).

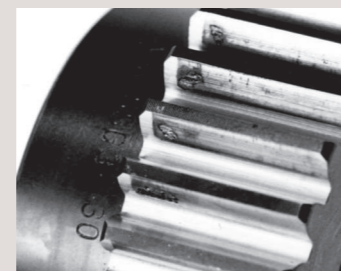

Poor tooth contact and pitting

Gear oil (equivalent to JIS gear oil category 2 No. 3)  
 The design conditions were load torque at 278 rpm, 42.5 kg/m (12 kW), 1.5 times the allowable bending strength, and 3 times the allowable surface durability torque.  
 The pitting occurred on the poor tooth contact area after 60 hours of continuous operation.

- ④ Due to the helix of helical gears, they produce thrust force (axial). The bearings must be selected properly to be able to handle these thrust forces. The direction of the thrust forces depend on the helix direction and the direction of rotation as shown below.  
 For details, use gear calculation software GCSW.

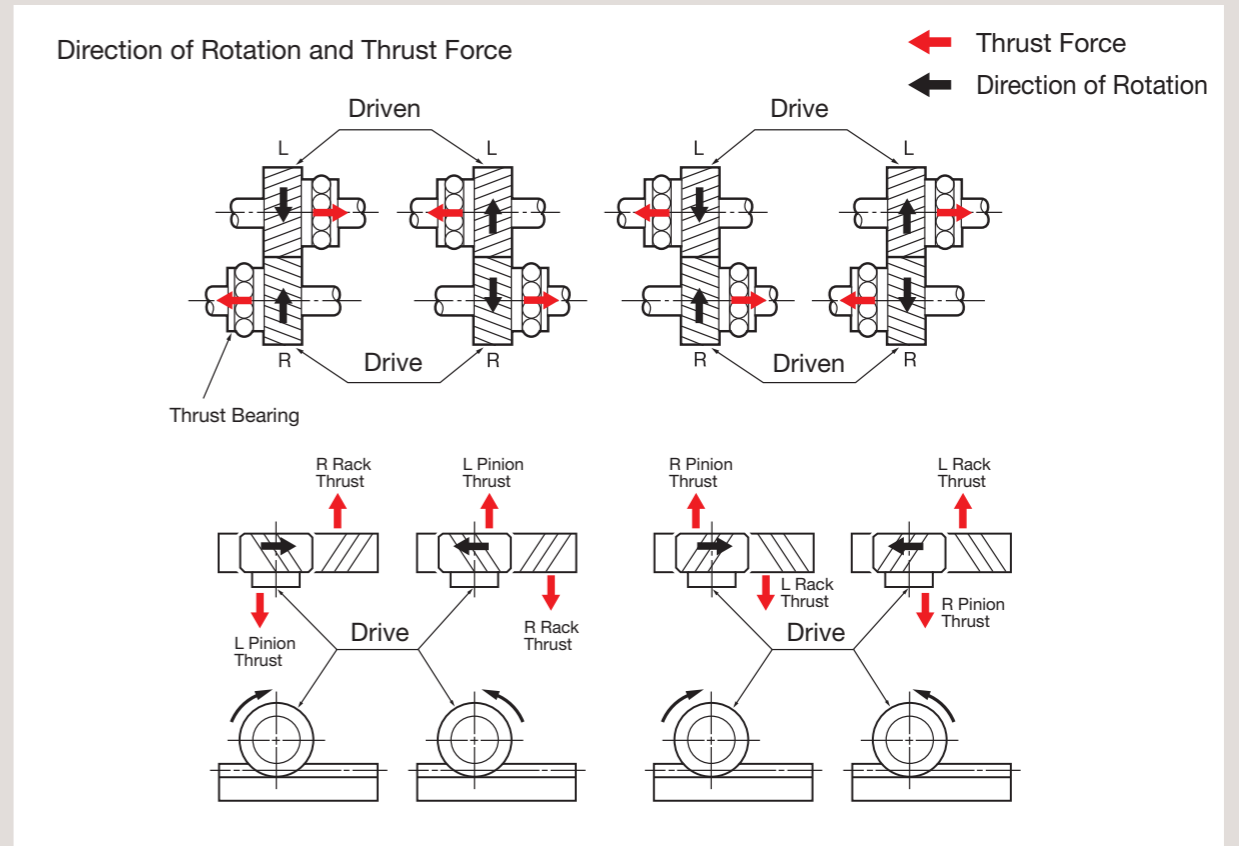

#### 3. Cautions on Starting

- ① Check the following items before starting.
  - Are the gears installed securely?
  - Is there uneven tooth contact?
  - Is there adequate backlash?  
(Be sure to avoid zero-backlash.)
  - Has proper lubrication been supplied?
- ② If gears are exposed, be sure to attach a safety cover to ensure safety. Also, be careful not to touch rotating gears.
- ③ If there is any abnormality such as noise or vibration during startup, stop the operation immediately and check the assembly condition such as tooth contact, eccentricity and looseness.

KHK considers safety a priority in the use of our products.

When handling, adding secondary operations, assembling, and operating KHK products, please be aware of the following issues in order to prevent accidents.



##### Warning: Precautions for preventing physical and property damage

1. When using KHK products, follow relevant safety regulations (Occupational Safety and Health Regulations, etc.).
2. Pay attention to the following items when installing, removing, or performing maintenance and inspection of the product.
  - ① Turn off the power switch.
  - ② Do not reach or crawl under the product.
  - ③ Wear appropriate clothing and protective equipment for the work.



##### Caution Cautions in Preventing Accidents

1. Before using a KHK product, read the precautions in the catalog carefully in order to use it correctly.
2. Avoid use in environments that may adversely affect the product.
3. Our products are manufactured under a superior quality control system based on the ISO9000 quality management system; if you notice any malfunctions upon purchasing a product, please contact the supplier.



Specifications	
Precision grade	JIS grade N6 (JIS B1702-1: 1998)*
Reference section of gear	Rotating plane
Gear teeth	Standard full depth
Transverse pressure angle	20°
Helix angle	21°30'
Material	SCM440
Heat treatment	Thermal refined, gear teeth induction hardened
Tooth hardness	50 to 60HRC
Surface treatment	Black oxide coated except for teeth

\* The precision grade of J Series products is equivalent to the value shown in the table.

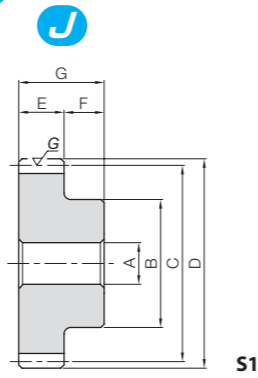

Usable in the assembly distance of the spur gear.

KHG ground helical gears use a "transverse" module. The assembly distance is the same as spur gear pairs with the same module and number of teeth. Improved strength and low noise: Take the next step up from spur gears.

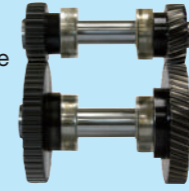

J Series

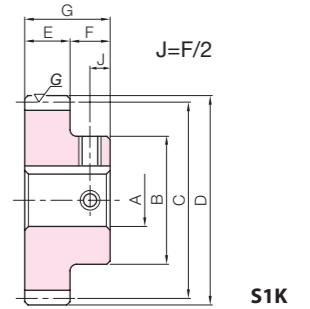
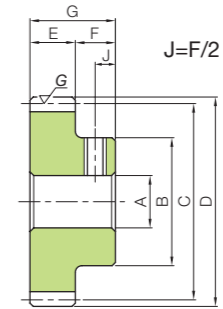

To order J Series products, please specify: **Catalog No. + J + BORE.**

Catalog Number	No. of teeth	Direction of helix	Shape	Bore A <sub>H7</sub>	Hub dia. B	Pitch dia. C	Outside dia. D	Face width E	Hub width F	Total length G	Allowable torque (N·m)		Allowable torque (kgf·m)		Backlash (mm)	Weight (kg)					
											Bending strength	Surface durability	Bending strength	Surface durability							
KHG1-20R KHG1-20L	20	R L	S1	6	17	20	22	8	10	18	7.79	4.98	0.79	0.51	0.08~0.16	0.034					
KHG1-24R KHG1-24L	24	R L			20	24	26										10.1	7.43	1.03	0.76	0.046
KHG1-28R KHG1-28L	28	R L			20	28	30										12.4	10.4	1.27	1.06	0.056
KHG1-30R KHG1-30L	30	R L		10	25	30	32	8	10	18	15.7	16.3	1.60	1.67	0.091	0.072					
KHG1-35R KHG1-35L	35	R L			25	35	37										15.1	15.4	1.54	1.57	0.088
KHG1-36R KHG1-36L	36	R L			25	36	38										15.7	16.3	1.60	1.67	0.091
KHG1-40R KHG1-40L	40	R L		12	30	40	42	8	10	18	17.9	20.5	1.83	2.10	0.12	0.18					
KHG1-48R KHG1-48L	48	R L			30	48	50										22.5	30.5	2.29	3.11	0.16
KHG1-50R KHG1-50L	50	R L			35	50	52										23.6	33.3	2.41	3.40	0.18
KHG1-60R KHG1-60L	60	R L		15	40	60	62	8	10	18	29.3	49.4	2.99	5.04	0.26	0.32					
KHG1-70R KHG1-70L	70	R L			40	70	72										35.2	68.9	3.58	7.02	0.32
KHG1-90R KHG1-90L	90	R L			50	90	92										46.9	118	4.78	12.1	0.53

\* The product shapes of J Series items are identified by background color.

Bore H7	6	8	10	12	14	15	16	17	18	19	20	22	25	28	30
Keyway J <sub>s9</sub>	—		4x1.8		5x2.3			6x2.8			8x3.3				
Screw size	—		4x1.8		5x2.3			6x2.8			8x3.3				
Catalog Number	M4	M5	M4			M5			M6						
KHG1-20R J BORE	S1T														
KHG1-20L J BORE	S1T														
KHG1-24R J BORE		S1T													
KHG1-24L J BORE		S1T													
KHG1-28R J BORE		S1T													
KHG1-28L J BORE		S1T													
KHG1-30R J BORE			S1K	S1K											
KHG1-30L J BORE			S1K	S1K											
KHG1-35R J BORE			S1K	S1K											
KHG1-35L J BORE			S1K	S1K											
KHG1-36R J BORE			S1K	S1K											
KHG1-36L J BORE			S1K	S1K											
KHG1-40R J BORE			S1K	S1K	S1K	S1K	S1K	S1K							
KHG1-40L J BORE			S1K	S1K	S1K	S1K	S1K	S1K							
KHG1-48R J BORE			S1K	S1K	S1K	S1K	S1K	S1K							
KHG1-48L J BORE			S1K	S1K	S1K	S1K	S1K	S1K							
KHG1-50R J BORE			S1K	S1K	S1K	S1K	S1K	S1K	S1K						
KHG1-50L J BORE			S1K	S1K	S1K	S1K	S1K	S1K	S1K						
KHG1-60R J BORE			S1K	S1K	S1K	S1K	S1K	S1K	S1K	S1K	S1K	S1K			
KHG1-60L J BORE			S1K	S1K	S1K	S1K	S1K	S1K	S1K	S1K	S1K	S1K	S1K		
KHG1-70R J BORE			S1K	S1K	S1K	S1K	S1K	S1K	S1K	S1K	S1K	S1K	S1K		
KHG1-70L J BORE			S1K	S1K	S1K	S1K	S1K	S1K	S1K	S1K	S1K	S1K	S1K	S1K	
KHG1-90R J BORE			S1K	S1K	S1K	S1K	S1K	S1K	S1K	S1K	S1K	S1K	S1K	S1K	S1K
KHG1-90L J BORE			S1K	S1K	S1K	S1K	S1K	S1K	S1K	S1K	S1K	S1K	S1K	S1K	S1K

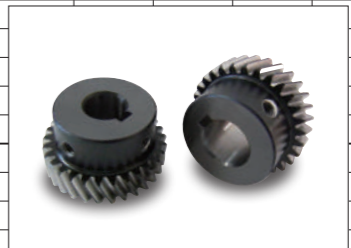



Specifications	
Precision grade	JIS grade N6 (JIS B1702-1: 1999)*
Reference section of gear	Rotating plane
Gear teeth	Standard full depth
Transverse pressure angle	20°
Helix angle	21°30'
Material	SCM440
Heat treatment	Thermal refined, gear teeth induction hardened
Tooth hardness	50 to 60HRC
Surface treatment	Black oxide coated except for teeth

\* The precision grade of J Series products is equivalent to the value shown in the table.

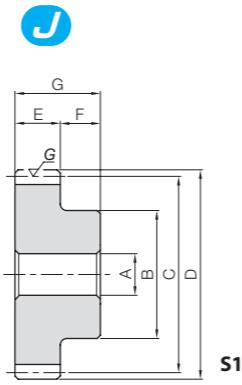

S1

Usable in the assembly distance of the spur gear.

KHG ground helical gears use a "transverse" module. The assembly distance is the same as spur gear pairs with the same module and number of teeth. Improved strength and low noise: Take the next step up from spur gears.

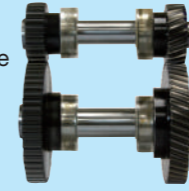

J Series

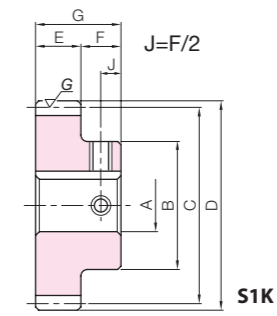

S1K



To order J Series products, please specify: **Catalog No. + J + BORE.**

Catalog Number	No. of teeth	Direction of helix	Shape	Bore AH7	Hub dia. B	Pitch dia. C	Outside dia. D	Face width E	Hub width F	Total length G	Allowable torque (N-m)		Allowable torque (kgf-m)		Backlash (mm)	Weight (kg)								
											Bending strength	Surface durability	Bending strength	Surface durability										
KHG1.5-20R KHG1.5-20L	20	R L	S1		24	30	33	12	12	24	26.3	18.5	2.68	1.89	0.08~0.16	0.088								
KHG1.5-22R KHG1.5-22L	22	R L															26	33	36	27.4	20.8	2.79	2.12	0.11
KHG1.5-24R KHG1.5-24L	24	R L															28	36	39	30.9	25.3	3.15	2.58	0.13
KHG1.5-25R KHG1.5-25L	25	R L															30	37.5	40.5	32.7	27.7	3.33	2.83	0.15
KHG1.5-26R KHG1.5-26L	26	R L															32	39	42	34.5	30.2	3.52	3.08	0.17
KHG1.5-28R KHG1.5-28L	28	R L															36	42	45	38.1	35.7	3.89	3.64	0.19
KHG1.5-30R KHG1.5-30L	30	R L															38	45	48	41.8	41.6	4.26	4.24	0.22
KHG1.5-32R KHG1.5-32L	32	R L															40	48	51	45.5	48.0	4.64	4.89	0.26
KHG1.5-36R KHG1.5-36L	36	R L															45	54	57	52.9	62.2	5.40	6.35	0.33
KHG1.5-40R KHG1.5-40L	40	R L															50	60	63	60.5	78.5	6.17	8.00	0.42
KHG1.5-48R KHG1.5-48L	48	R L															50	72	75	75.8	117	7.73	12.0	0.52
KHG1.5-50R KHG1.5-50L	50	R L															60	75	78	79.6	128	8.12	13.1	0.63
KHG1.5-52R KHG1.5-52L	52	R L															60	78	81	83.5	140	8.51	14.2	0.67
KHG1.5-60R KHG1.5-60L	60	R L															60	90	93	99.1	191	10.1	19.5	0.81
KHG1.5-80R KHG1.5-80L	80	R L															70	120	123	132	343	13.5	35.0	1.37
KHG1.5-90R KHG1.5-90L	90	R L															70	135	138	151	442	15.4	45.1	1.65
KHG1.5-100R KHG1.5-100L	100	R L															70	150	153	170	554	17.4	56.5	1.97

Bore H7	* The product shapes of J Series items are identified by background color.																							
	12	14	15	16	17	18	19	20	22	25	28	30	32	35	40									
Keyway Js9	4x1.8				5x2.3				6x2.8				8x3.3				10x3.3				12x3.3			
Screw size	M4				M5				M6				M8											
Catalog Number	S1K				S1K				S1K				S1K				S1K							
KHG1.5-20R J BORE	S1K																							
KHG1.5-20L J BORE	S1K																							
KHG1.5-22R J BORE	S1K																							
KHG1.5-22L J BORE	S1K																							
KHG1.5-24R J BORE	S1K	S1K	S1K																					
KHG1.5-24L J BORE	S1K	S1K	S1K																					
KHG1.5-25R J BORE	S1K	S1K	S1K	S1K	S1K																			
KHG1.5-25L J BORE	S1K	S1K	S1K	S1K	S1K																			
KHG1.5-26R J BORE	S1K	S1K	S1K	S1K	S1K																			
KHG1.5-26L J BORE	S1K	S1K	S1K	S1K	S1K																			
KHG1.5-28R J BORE			S1K	S1K	S1K	S1K	S1K	S1K																
KHG1.5-28L J BORE			S1K	S1K	S1K	S1K	S1K	S1K																
KHG1.5-30R J BORE			S1K	S1K	S1K	S1K	S1K	S1K	S1K															
KHG1.5-30L J BORE			S1K	S1K	S1K	S1K	S1K	S1K	S1K															
KHG1.5-32R J BORE			S1K	S1K	S1K	S1K	S1K	S1K	S1K															
KHG1.5-32L J BORE			S1K	S1K	S1K	S1K	S1K	S1K	S1K															
KHG1.5-36R J BORE			S1K	S1K	S1K	S1K	S1K	S1K	S1K	S1K														
KHG1.5-36L J BORE			S1K	S1K	S1K	S1K	S1K	S1K	S1K	S1K														
KHG1.5-40R J BORE			S1K	S1K	S1K	S1K	S1K	S1K	S1K	S1K	S1K	S1K												
KHG1.5-40L J BORE			S1K	S1K	S1K	S1K	S1K	S1K	S1K	S1K	S1K	S1K	S1K											
KHG1.5-48R J BORE						S1K	S1K	S1K	S1K	S1K	S1K	S1K	S1K											
KHG1.5-48L J BORE						S1K	S1K	S1K	S1K	S1K	S1K	S1K	S1K											
KHG1.5-50R J BORE						S1K	S1K	S1K	S1K	S1K	S1K	S1K	S1K	S1K										
KHG1.5-50L J BORE						S1K	S1K	S1K	S1K	S1K	S1K	S1K	S1K	S1K										
KHG1.5-52R J BORE						S1K	S1K	S1K	S1K	S1K	S1K	S1K	S1K	S1K										
KHG1.5-52L J BORE						S1K	S1K	S1K	S1K	S1K	S1K	S1K	S1K	S1K										
KHG1.5-60R J BORE									S1K	S1K	S1K	S1K	S1K	S1K	S1K									
KHG1.5-60L J BORE									S1K	S1K	S1K	S1K	S1K	S1K	S1K									
KHG1.5-80R J BORE									S1K	S1K	S1K	S1K	S1K	S1K	S1K									
KHG1.5-80L J BORE									S1K	S1K	S1K	S1K	S1K	S1K	S1K									
KHG1.5-90R J BORE									S1K	S1K	S1K	S1K	S1K	S1K	S1K									
KHG1.5-90L J BORE									S1K	S1K	S1K	S1K	S1K	S1K	S1K									
KHG1.5-100R J BORE									S1K	S1K	S1K	S1K	S1K	S1K	S1K									
KHG1.5-100L J BORE									S1K	S1K	S1K	S1K	S1K	S1K	S1K									





Specifications	
Precision grade	JIS grade N6 (JIS B1702-1: 1998)*
Reference section of gear	Rotating plane
Gear teeth	Standard full depth
Transverse pressure angle	20°
Helix angle	21°30'
Material	SCM440
Heat treatment	Thermal refined, gear teeth induction hardened
Tooth hardness	50 to 60HRC
Surface treatment	Black oxide coated except for teeth

\* The precision grade of J Series products is equivalent to the value shown in the table.

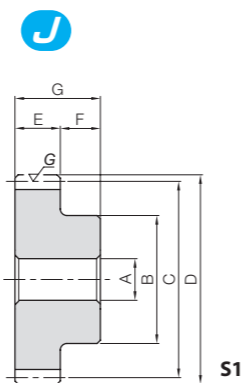

Usable in the assembly distance of the spur gear.

KHG ground helical gears use a "transverse" module. The assembly distance is the same as spur gear pairs with the same module and number of teeth. Improved strength and low noise: Take the next step up from spur gears.

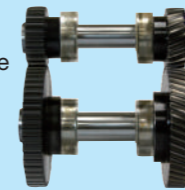

J Series

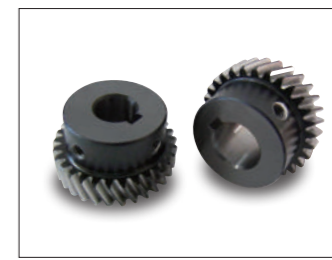
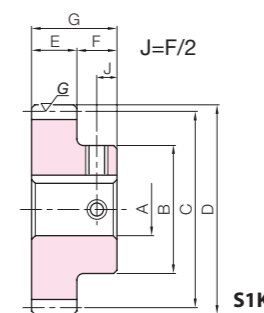

To order J Series products, please specify: **Catalog No. + J + BORE.**

Catalog Number	No. of teeth	Direction of helix	Shape	Bore A <sub>H7</sub>	Hub dia. B	Pitch dia. C	Outside dia. D	Face width E	Hub width F	Total length G	Allowable torque (N·m)		Allowable torque (kgf·m)		Backlash (mm)	Weight (kg)				
											Bending strength	Surface durability	Bending strength	Surface durability						
KHG2-15R	15	R	S1	12	24	30	34	16	13	29	40.5	22.8	4.13	2.32	0.10~0.20	0.11				
KHG2-15L		L																		
KHG2-18R	18	R			30	36	40				40.5	22.8	4.13	2.32						
KHG2-18L		L																		
KHG2-20R	20	R			32	40	44										48.5	31.9	4.95	3.25
KHG2-20L		L																		
KHG2-22R	22	R		36	44	48	56.6	40.8	5.77	4.16										
KHG2-22L		L																		
KHG2-25R	25	R		40	50	54					64.9	50.6	6.62	5.16						
KHG2-25L		L																		
KHG2-26R	26	R		42	52	56									77.5	67.3	7.90	6.86		
KHG2-26L		L																		
KHG2-28R	28	R	45	56	60	81.8	73.4	8.34	7.49											
KHG2-28L		L																		
KHG2-30R	30	R	50	60	64					90.4	86.6	9.21	8.83							
KHG2-30L		L																		
KHG2-32R	32	R	50	64	68									99.1	101	10.1	10.3			
KHG2-32L		L																		
KHG2-35R	35	R	50	70	74	108	117	11.0	11.9											
KHG2-35L		L																		
KHG2-36R	36	R	50	72	76					121	142	12.3	14.5							
KHG2-36L		L																		
KHG2-40R	40	R	60	80	84									126	151	12.8	15.4			
KHG2-40L		L																		
KHG2-45R	45	R	60	90	94	143	191	14.6	19.5											
KHG2-45L		L																		
KHG2-48R	48	R	60	96	100					166	248	16.9	25.3							
KHG2-48L		L																		
KHG2-50R	50	R	60	100	104									172	273	17.5	27.9			
KHG2-50L		L																		
KHG2-60R	60	R	65	120	124	181	299	18.4	30.5											
KHG2-60L		L																		
KHG2-70R	70	R	70	140	144					225	447	22.9	45.6							
KHG2-70L		L																		
KHG2-80R	80	R	80	160	164									269	625	27.4	63.7			
KHG2-80L		L																		
KHG2-90R	90	R	90	180	184	301	799	30.7	81.4											
KHG2-90L		L																		
KHG2-100R	100	R	90	180	184					344	1030	35.0	105							
KHG2-100L		L																		
KHG2-100R	100	R	100	200	204									387	1290	39.4	132			
KHG2-100L		L																		

Bore H7	* The product shapes of J Series items are identified by background color.																	
	12	14	15	16	17	18	19	20	22	25	28	30	32	35	40	45	50	
Keyway J <sub>s9</sub>	4x1.8			5x2.3			6x2.8			8x3.3			10x3.3		12x3.3		14x3.8	
Screw size	M4			M5			M6			M8			M10					
Catalog Number	S1K																	
KHG2-15R J BORE	S1K																	
KHG2-15L J BORE	S1K																	
KHG2-18R J BORE	S1K																	
KHG2-18L J BORE	S1K																	
KHG2-20R J BORE	S1K																	
KHG2-20L J BORE	S1K																	
KHG2-22R J BORE	S1K																	
KHG2-22L J BORE	S1K																	
KHG2-25R J BORE	S1K																	
KHG2-25L J BORE	S1K																	
KHG2-26R J BORE	S1K																	
KHG2-26L J BORE	S1K																	
KHG2-28R J BORE	S1K																	
KHG2-28L J BORE	S1K																	
KHG2-30R J BORE	S1K																	
KHG2-30L J BORE	S1K																	
KHG2-32R J BORE	S1K																	
KHG2-32L J BORE	S1K																	
KHG2-35R J BORE	S1K																	
KHG2-35L J BORE	S1K																	
KHG2-36R J BORE	S1K																	
KHG2-36L J BORE	S1K																	
KHG2-40R J BORE	S1K																	
KHG2-40L J BORE	S1K																	
KHG2-45R J BORE	S1K																	
KHG2-45L J BORE	S1K																	
KHG2-48R J BORE	S1K																	
KHG2-48L J BORE	S1K																	
KHG2-50R J BORE	S1K																	
KHG2-50L J BORE	S1K																	
KHG2-60R J BORE	S1K																	
KHG2-60L J BORE	S1K																	
KHG2-70R J BORE	S1K																	
KHG2-70L J BORE	S1K																	
KHG2-80R J BORE	S1K																	
KHG2-80L J BORE	S1K																	
KHG2-90R J BORE	S1K																	
KHG2-90L J BORE	S1K																	
KHG2-100R J BORE	S1K																	
KHG2-100L J BORE	S1K																	





Specifications	
Precision grade	JIS grade N8 (JIS B1702-1: 1998)
Reference section of gear	Normal plane
Gear teeth	Standard full depth
Normal pressure angle	20°
Helix angle	15°
Material	S45C
Heat treatment	—
Tooth hardness	(less than 194HB)
Surface treatment	Black oxide coating

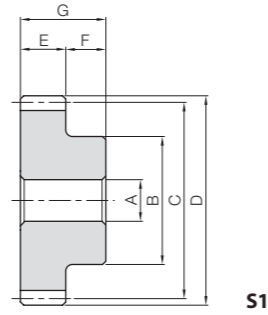

Catalog Number	Module	No. of teeth	Direction of helix	Shape	Bore		Pitch dia.	Outside dia.	Face width	Hub width		Total length
					AH7	B				C	D	
SH2-15R SH2-15L	m2	15	R L	S1	12	24	31.06	35.06	25	10	35	
SH2-20R SH2-20L		20	R L		12	32	41.41	45.41				
SH2-30R SH2-30L		30	R L		12	50	62.12	66.12				
SH2-40R SH2-40L		40	R L		18	60	82.82	86.82				
SH2-60R SH2-60L		60	R L		18	70	124.23	128.23				
SH2-90R SH2-90L		90	R L		18	120	186.35	190.35				
SH3-15R SH3-15L	m3	15	R L	S1	15	36	46.59	52.59	35	15	50	
SH3-20R SH3-20L		20	R L		15	50	62.12	68.12				
SH3-30R SH3-30L		30	R L		20	70	93.17	99.17				
SH3-40R SH3-40L		40	R L		20	80	124.23	130.23				
SH3-60R SH3-60L		60	R L		20	140	186.35	192.35				

Allowable torque (N·m)		Allowable torque (kgf·m)		Backlash (mm)	Weight (kg)	Catalog Number
Bending strength	Surface durability	Bending strength	Surface durability			
43.7	2.90	4.46	0.30	0.12~0.26	0.15	SH2-15R SH2-15L
67.1	5.85	6.84	0.60		0.30	SH2-20R SH2-20L
117	15.3	11.9	1.56		0.72	SH2-30R SH2-30L
169	28.9	17.2	2.95		1.21	SH2-40R SH2-40L
275	70.8	28.0	7.22		2.61	SH2-60R SH2-60L
437	173	44.6	17.6		6.17	SH2-90R SH2-90L
138	9.67	14.0	0.99	0.14~0.32	0.52	SH3-15R SH3-15L
211	19.4	21.6	1.98		0.99	SH3-20R SH3-20L
368	50.2	37.5	5.12		2.20	SH3-30R SH3-30L
531	95.5	54.1	9.73		3.80	SH3-40R SH3-40L
866	236	88.3	24.0		9.18	SH3-60R SH3-60L

### Reference Section of Gears

Transverse module (SH helical gears) and normal module (KHG ground helical gears) are available for the gear teeth according to the gear reference cross section. Even if products have the same helix angle and module, transverse and normal module gears have different gear teeth and thus cannot engage.

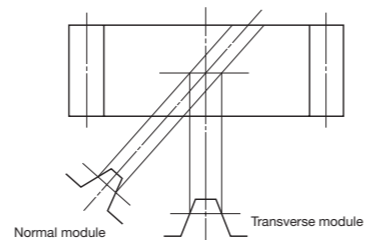

\* Above is for illustration purposes only and differs from actual tooth forms.

Center Distance Table of SH Helical Gears

Catalog Number	SH2-15 <sup>R</sup> <sub>L</sub>	SH2-20 <sup>R</sup> <sub>L</sub>	SH2-30 <sup>R</sup> <sub>L</sub>	SH2-40 <sup>R</sup> <sub>L</sub>	SH2-60 <sup>R</sup> <sub>L</sub>	SH2-90 <sup>R</sup> <sub>L</sub>
SH2-15 <sup>R</sup> <sub>L</sub>	31.06	—	—	—	—	—
SH2-20 <sup>R</sup> <sub>L</sub>	36.23	41.41	—	—	—	—
SH2-30 <sup>R</sup> <sub>L</sub>	46.59	51.76	62.12	—	—	—
SH2-40 <sup>R</sup> <sub>L</sub>	56.94	62.12	72.47	82.82	—	—
SH2-60 <sup>R</sup> <sub>L</sub>	77.65	82.82	93.17	103.53	124.23	—
SH2-90 <sup>R</sup> <sub>L</sub>	108.70	113.88	124.23	134.59	155.29	186.35

Center Distance Table of SH Helical Gears

Catalog Number	SH3-15 <sup>R</sup> <sub>L</sub>	SH3-20 <sup>R</sup> <sub>L</sub>	SH3-30 <sup>R</sup> <sub>L</sub>	SH3-40 <sup>R</sup> <sub>L</sub>	SH3-60 <sup>R</sup> <sub>L</sub>
SH3-15 <sup>R</sup> <sub>L</sub>	46.59	—	—	—	—
SH3-20 <sup>R</sup> <sub>L</sub>	54.35	62.12	—	—	—
SH3-30 <sup>R</sup> <sub>L</sub>	69.88	77.65	93.17	—	—
SH3-40 <sup>R</sup> <sub>L</sub>	85.41	93.17	108.70	124.23	—
SH3-60 <sup>R</sup> <sub>L</sub>	116.47	124.23	139.76	155.29	186.35



### KHG Ground Helical Gears

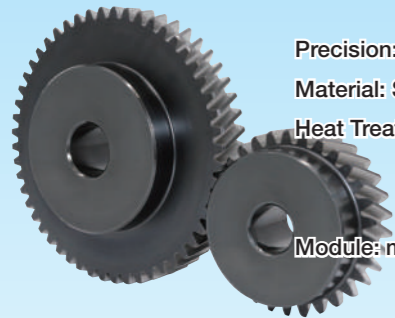

Precision: JIS Grade N6  
Material: SCM440  
Heat Treatment: Thermal refined / gear teeth induction hardened  
Module: m1 to 3

Please see Page 194 for more details.

### KRHG/KRHGF/KRHGFD Ground Helical Racks

Precision: KHK Grade 1  
Material: SCM440  
Heat Treatment: Thermal refining only  
Module: m1 to 3  
Nominal Total Length: 100, 500, 1,000 mm

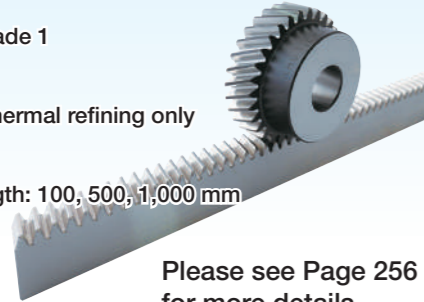

Please see Page 256 for more details.

### SH Helical Gears



Precision: JIS Grade N8  
Material: S45C  
Heat Treatment: -  
Module: m2, 3

Please see Page 202 for more details.

### SRH·SRHF·SRHFD Helical Racks

Precision: KHK Grade 5  
Material: S45C  
Heat Treatment: -  
Module: m2, 3  
Nominal Total Length: 100, 500, 1,000 mm



Please see Page 258 for more details.

### ZSTP Ground Helical Gears

**Dedicated for racks**



Precision: JIS Grade N6  
Material: SCM440  
Heat Treatment: Thermal refined / gear teeth induction hardened  
Module: m2 to 6

Please see Page 262 for more details.

### SHE Helical Gears

**Dedicated for racks**



Precision: JIS Grade N8  
Material: S45C  
Heat Treatment: -  
Module: m1.5 to 6

Please see Page 260 for more details.

### ZST/ZSTD

### Hardened Ground Helical Racks

Precision: DIN Grade 6 (KHK Grade 2 equivalent)  
Material: DIN C45 (JIS S45C equivalent)  
Heat Treatment: Gear teeth induction hardened  
Module: m2 to 6  
Nominal Total Length: 1,000, 2,000 mm

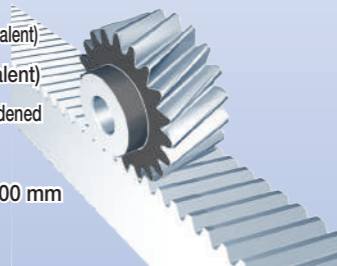

Please see Page 262 for more details.

### SRHEF Helical Racks

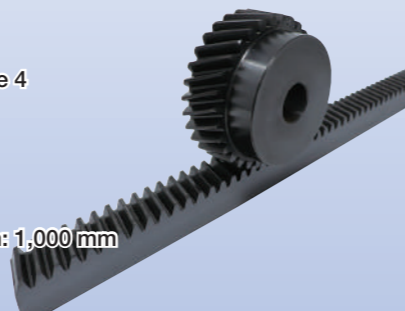

Precision: KHK Grade 4  
Material: S45C  
Heat Treatment: -  
Module: m1.5 to 6  
Nominal Total Length: 1,000 mm



Please see Page 260 for more details.



# Internal Gears

SI Steel Internal Gears	SIR Internal Ring Gears
	
Material: S45C m0.5-3 Page 208	Material: S45C m2-3 Page 210

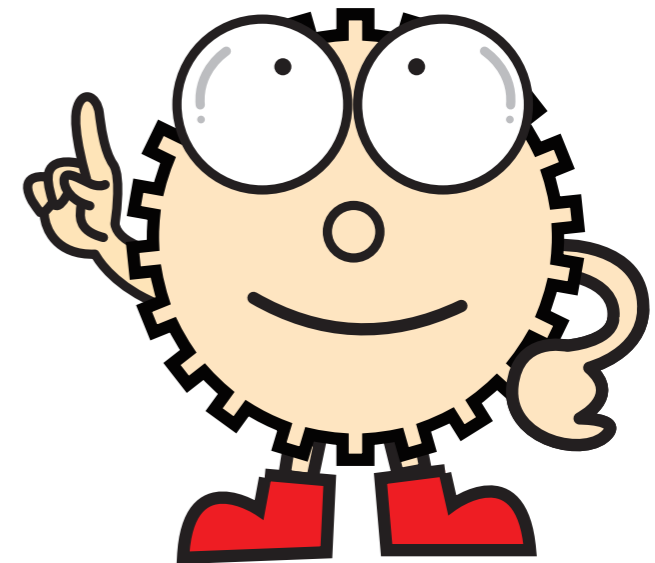

### Catalog Number of KHK Stock Gears

The Catalog Number for KHK stock gears is based on the simple formula listed below. Please order KHK gears by specifying the Catalog Numbers.

(Example) Internal Gears

**S I R 2 - 120**

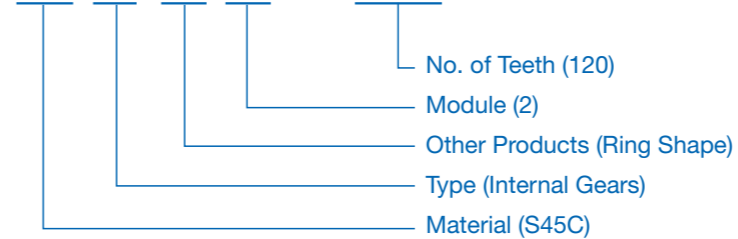

**Material**  
S S45C

**Type**  
I Internal Gears

**Other Information**  
R Ring Gears